

# DAYTONA

---

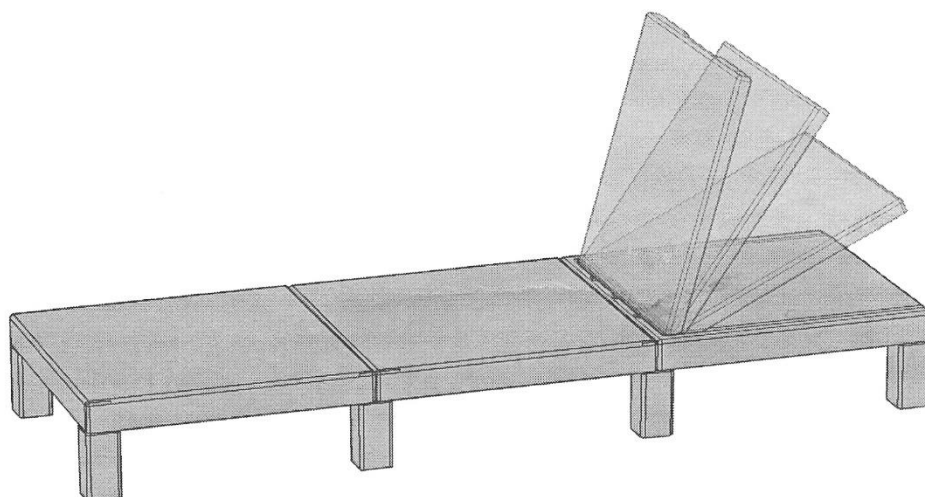



"DAYTONA"/REV.0.2 / 546531 / 442022

**ALLIBERT** 

Ericssonstraat 17 | 5121 MK RIJEN | The Netherlands | [WWW.ALLIBERT-OUTDOOR.COM](http://WWW.ALLIBERT-OUTDOOR.COM)



NEN 581		
		
✓	✓	✗

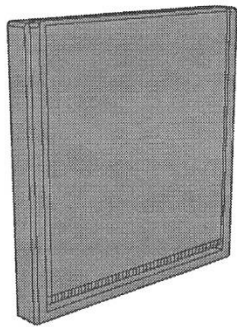
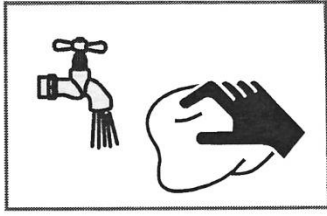

DRB (1x)

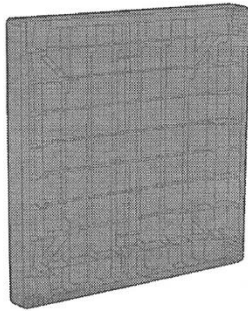

TA (2x)



S (8x)

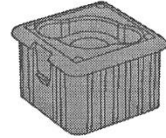

M (8x)

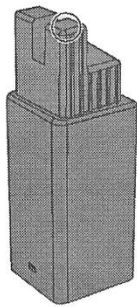

LA (2x)

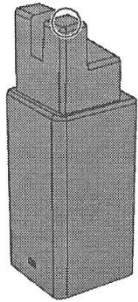

LB (2x)

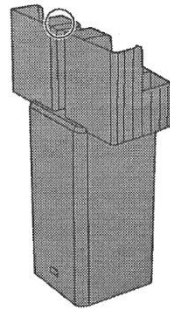

LC (4x)

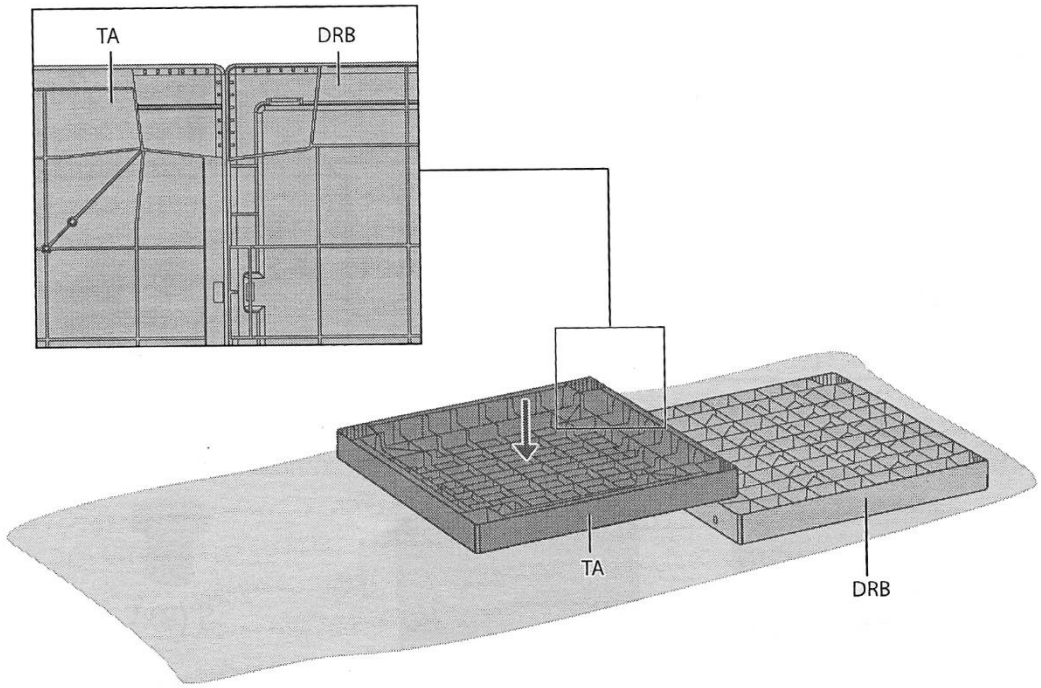

1

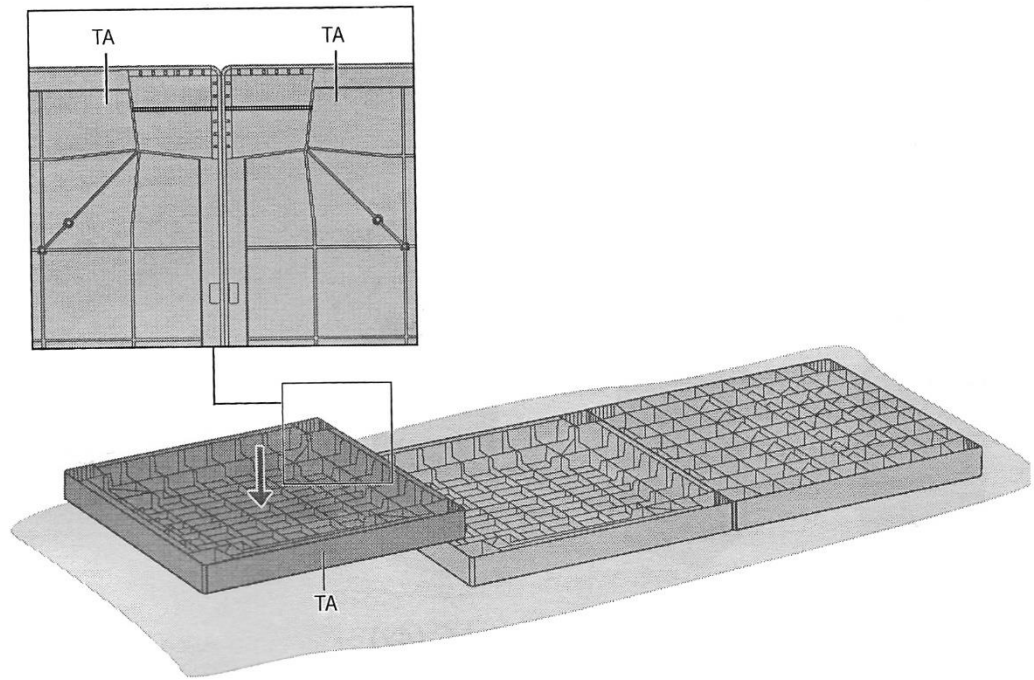

2

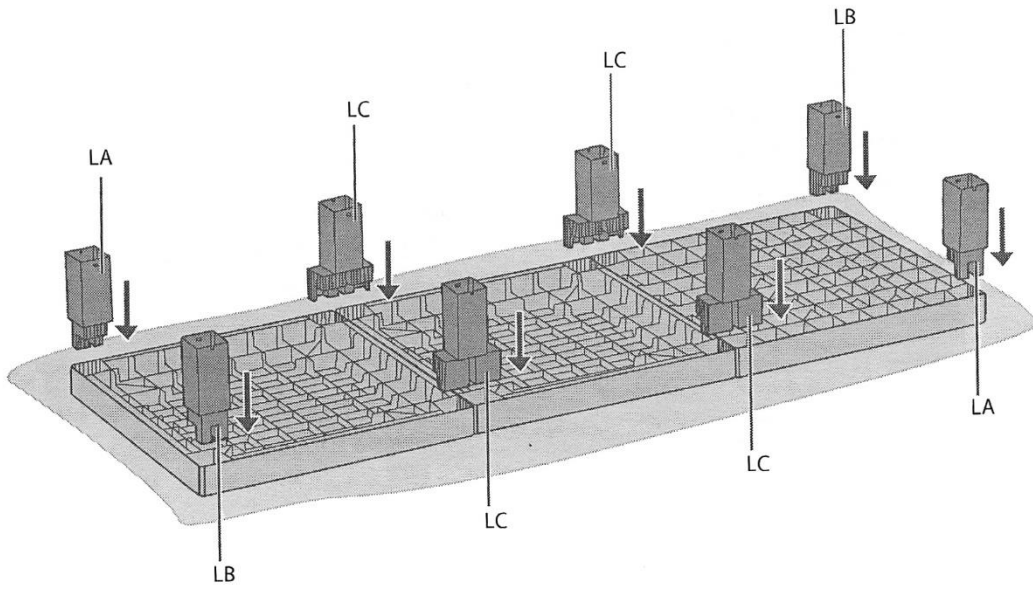

3

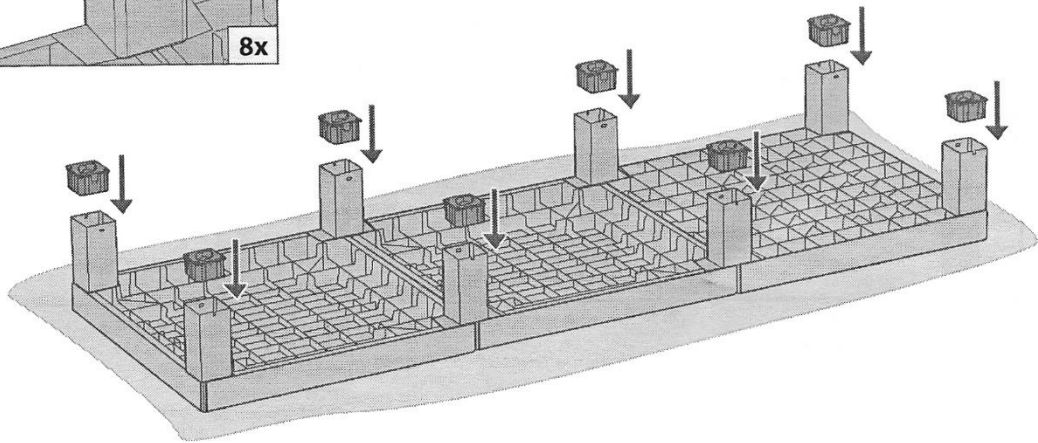
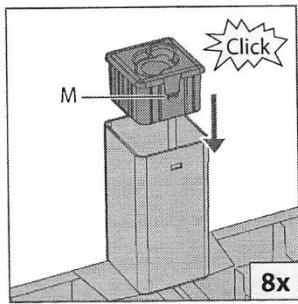

4

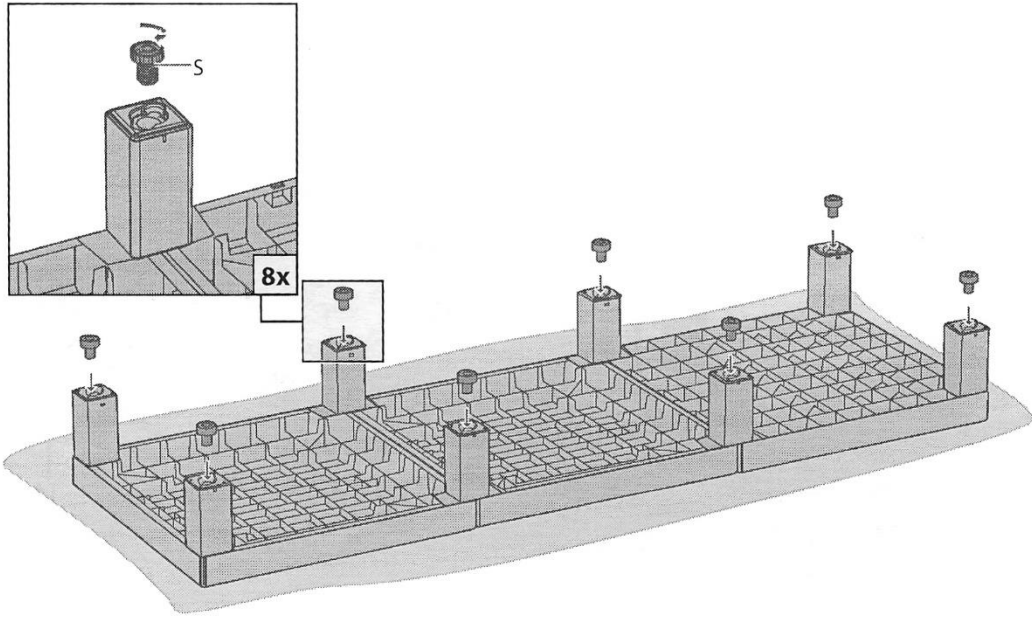

---

5

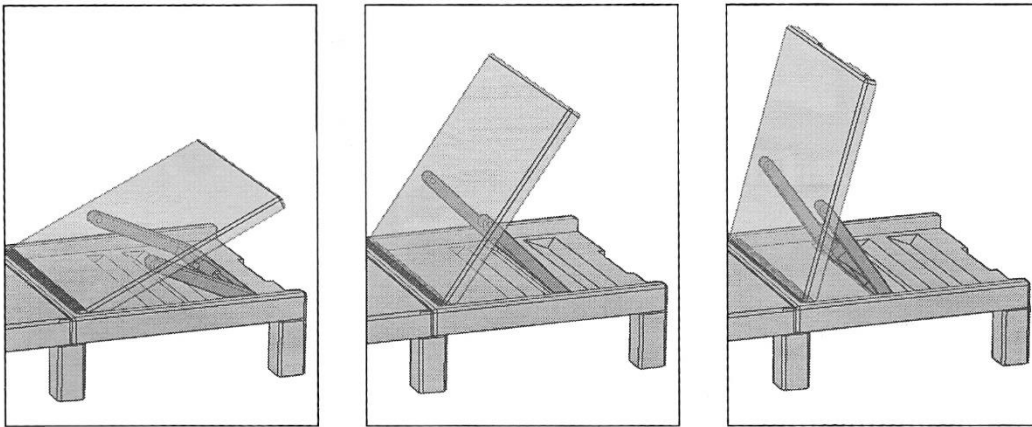

---

6

